

RoHS
COMPLIANT

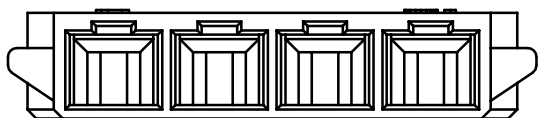
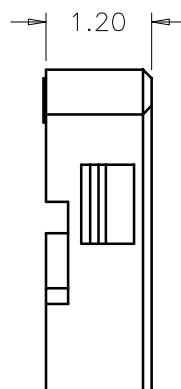
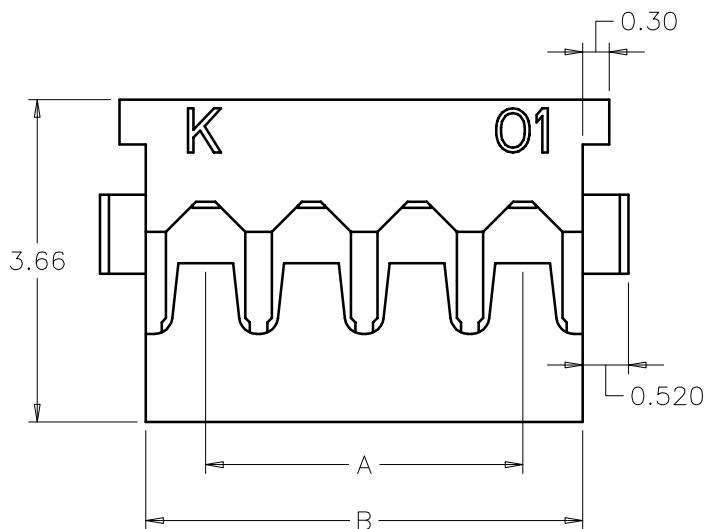
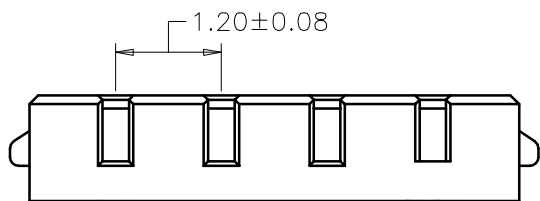

◆ SPECIFICATIONS

- Current rating: 1.5A AC, DC
- Voltage rating: 50V AC, DC
- Temperature range: -40°C ~ +105°C
- Insulation resistance: 100MΩ Min.
- Withstanding voltage: 500V AC/ minute.
- Contact resistance: 20mΩ Max.

Material: LCP UL94V-0

Suitable: E1202 series Crimp Terminal

Ordering code:

E1202 H00- NP X -HF
① ② ③ ④

- ① Series No.
- ② No. of Circuits
- ③ X: Product (A-Y) A: Black
- ④ HF: Halogen Free

PIN.	Dimension	
	A	B
2P	1.20	2.60
3P	2.40	3.80
4P	3.60	5.00
5P	4.80	6.20
6P	6.00	7.40
7P	7.20	8.60



MARK	REVISION DESCRIPTION	SIGNATURE	DATE
1	2	3	4

TOLERANCE
X.X ±0.30
X.XX ±0.20
X.XXX ±0.10
Angle ±2°

TITLE:
MX1.2 Housing

UNIT: mm SCALE: N/A

DRAWN: 张自豪 2020.05.09

CHECKED:

APPROVED:

SHEET: 1/1 PROJECTION

东莞市宏欣蓝电子有限公司

PART NO.: E1202H00-NPA-HF

REV.: A2 DRAWING NO.: E1202H

RoHS
COMPLIANT

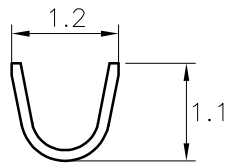
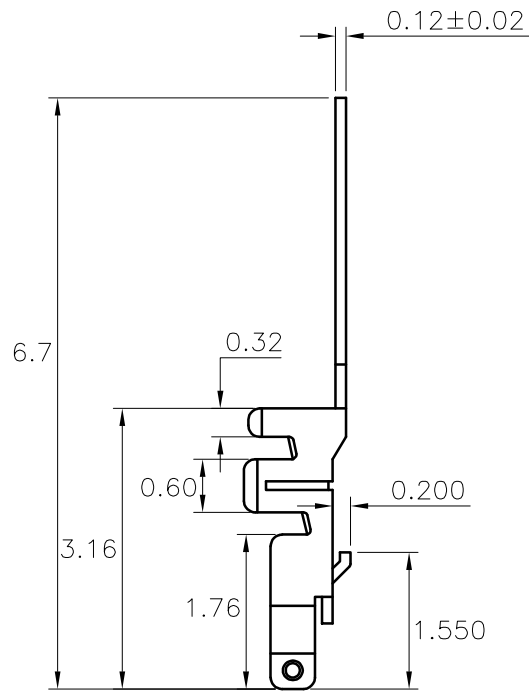
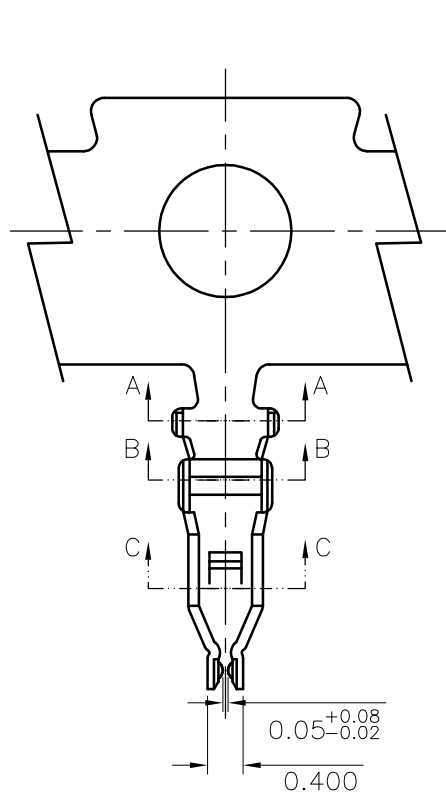

SECTION A-A

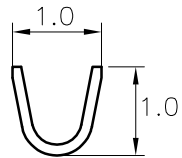

SECTION B-B

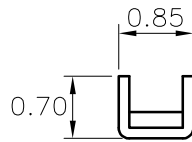

SECTION C-C

◆ SPECIFICATIONS

- Current rating: 1.5A AC, DC
- Voltage rating: 50V AC, DC
- Temperature range: -40°C ~ +105°C
- Insulation resistance: 100MΩ Min.
- Withstanding voltage: 500V AC/ minute.
- Contact resistance: 20mΩ Max.

Applicable Wires:

AWG#28~#30

Insulation O.D. : 0.75mm MAX

Material: Phosphor Bronze

Finish: Gold-flash over Nickel

Suitable: 1200 series Crimp Housing

Q'ty: 20,000 PCS/Reel

Ordering code:

E1202 TOP-5A
① ②

① Series No.

② 5A:Gold flash



MARK

1

2

3

4

5

6

7

8

9

TOLERANCE

X.X ±0.3

X.XX ±0.2

X.XXX ±0.1

Angle ±2°

TITLE:

MX1.2 Terminal

DRAWN: 张自豪 2020.05.09

CHECKED:

APPROVED:

东莞市宏欣蓝电子有限公司

PART NO.: E1202TOP-5A

UNIT:mm

SCALE:N/A

SHEET:1/1

PROJECTION

REV.:A3

DRAWING NO.:E1202TOP-5A

RoHS
COMPLIANT

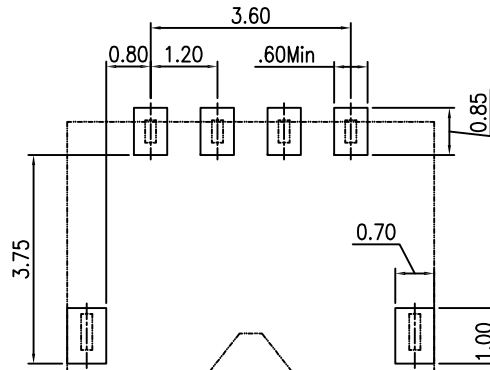
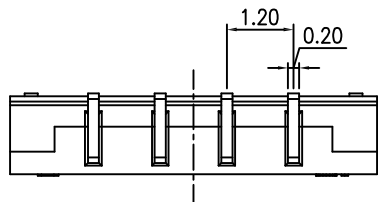

Recommended P.C.B. Layout
Total tolerance: ±0.05mm

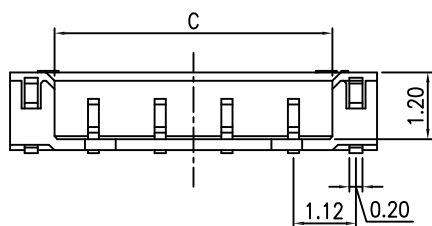
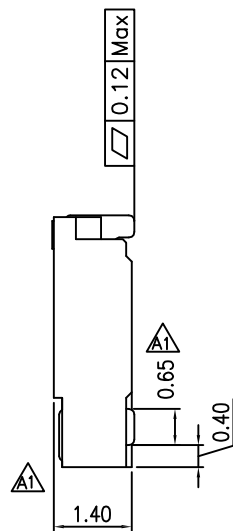
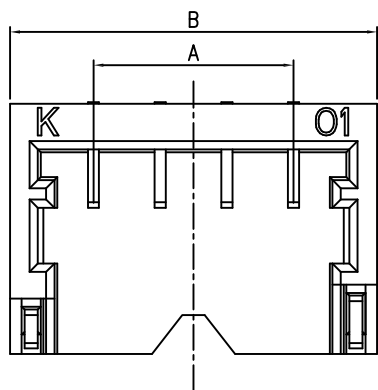

◆ SPECIFICATIONS

- Current rating: 1.5A AC, DC
- Voltage rating: 50V AC, DC
- Temperature range: -25°C ~ +85°C
- Insulation resistance: 100MΩ Min.
- Withstanding voltage: 500V AC/ minute.
- Contact resistance: 20mΩ Max.

Material:

Insulator: LCP UL 94V-0 Black
Contact: Phosphor bronze
Fitting Nail: Brass

Plating:

Contact: Gold Flash plated
Fitting Nail: Matte Tin plated

Circuits: 2~7

Suitable: E1202 series Housing

Ordering code:

E1202W90-NP X-5A-XX
① ② ③ ④ ⑤

- ① Series No.
- ② No. of Circuits
- ③ X : Product color(A--Y)
A : Black type
Blank : Natural type
- ④ 5A : Gold-flash
- ⑤ HF : Halogen Free
Blank : RoHS

PIN.	Dimension		
	A	B	C
2P	1.20	4.30	2.64
3P	2.40	5.50	3.84
4P	3.60	6.70	5.04
5P	4.80	7.90	6.24
6P	6.00	9.10	7.44
7P	7.20	10.30	8.64

④				GENERAL TOLERANCE	UNIT: mm	DATE	TITLE:			
③				.X ± 0.30	X° ± 2°	DRAWN: 张志豪	2017.02.10	MX1.20mm SMT 90°Wafer(宽焊脚)		
②				.XX ± 0.20	.X° ±	CHECKED:		PROJECT	PART NO.	E1202W90-NPX-5A-XX
①	张志豪	2019.5.15	修改焊片焊板尺寸0.40改为0.65mm及主体加胶	.XXX ± 0.10	.XX° ±	APPROVED: 张彬	2017.02.10	VER.	SCALE:	N/A
LTR	NAME	DATE	VERSION RECORD					A1	SHEET:	1/1
1	2	3	4	5	6	7	8	9	DRAWING NO. E1202W90	

东莞市宏欣蓝电子有限公司